

Standard Touchpad



Colorado Time Systems Touchpads have been used in competition in every continent on the globe.

Standard Surface Touchpad

▪ **Tough, Durable and Gentle**

Why do our touchpads show up at more swim meets than any other in the world? Their all-plastic construction is tough and durable, yet their textured, non-skid surface is gentle on swimmers' feet. The solid quarter inch plastic backbone, molded one-piece connectors and non-corrosive finish provide long-lasting reliability. Our touchpads can even be left in the water for the duration of an entire event.

▪ **Easy to Install, Stays in Place**

Set-up is easy, thanks to our universal mounting system customized for your pool. They hold your pads in place without hardware or holes (in most pools) and prevent unwanted vertical and lateral movement. Best of all, you don't need any tools.

▪ **Sensitive to the Lightest Touch**

Dependable, internally sealed switches record even the lightest swimmers' touch on the fully active face of all CTS pads, and also along the top edge of gutter-mounted pads. You get an accurate finish every time with no "dead spots."

▪ **A Perfect Size for Every Lane**

At Colorado Time Systems, we will help you select the perfect touchpad for your facility. Choose from standard sizes or custom widths, and flat wall or gutter mounts.

A caddy that holds up to ten gutter hung touchpads is available; please see separate data sheet or contact your CTS sales person for more information.

Revised 04/10

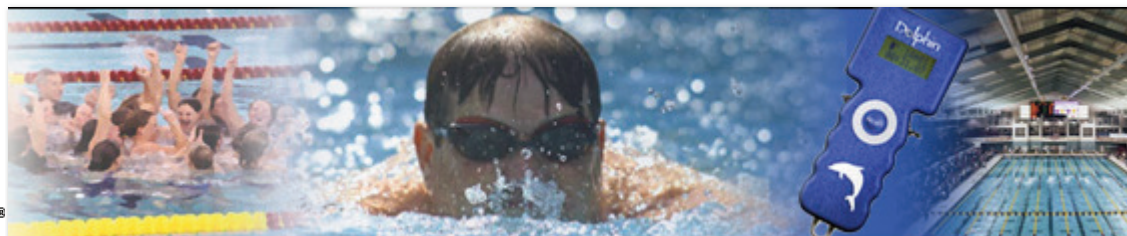

Standard Touchpad Specifications

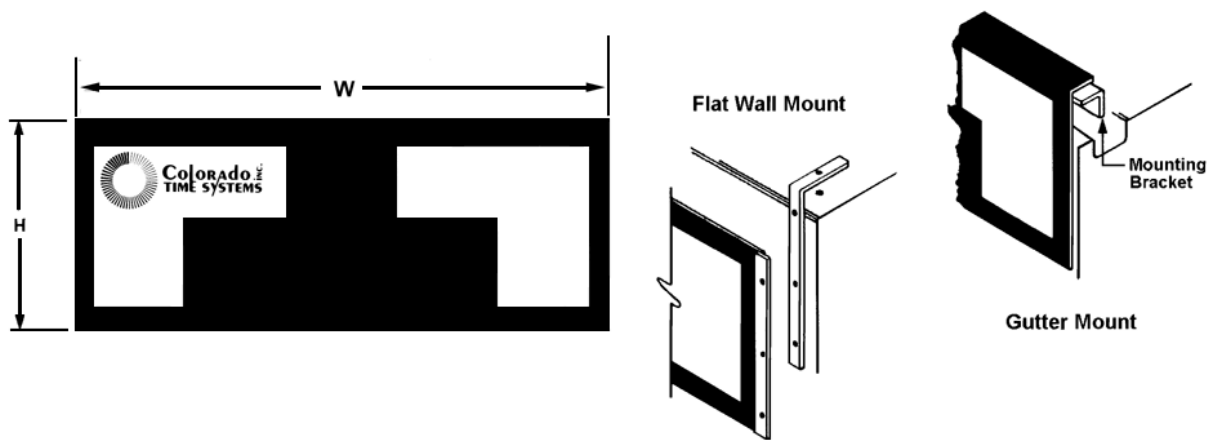

Description	Standard	Weight	Standard	Weight
	Gutterhung		Flatwall*	
188.5cm x 90cm FINA Touchpad	TP-188.5	47 lbs (21.3kg)	TP-188.5F	47 lbs (21.3 kg)
190cm x 90cm FINA Touchpad	TP-190	49 lbs (22.2kg)	TP-190F	49 lbs (22.2kg)
195cm x 90cm FINA Touchpad	TP-195	49 lbs (22.2 kg)	TP-195F	49 lbs (22.2kg)
240cm x 90cm FINA Touchpad	TP-240	66 lbs (30kg)	TP-240F	66 lbs (30kg)
60in x 22in Touchpad (152.40cm x 55.88cm) Recommended for lanes 66 to 84 inches wide	TP-60	28 lbs (12.7kg)		
60in x 24in Touchpad (152.40cm x 60.96cm) Recommended for lanes 66 to 84 inches wide			TP-60F	33 lbs (15kg)
78in x 22in Touchpad (198.12cm x 55.88cm) Recommended for lanes 84 to 96 inches wide	TP-78	35 lbs (15.9kg)		
78in x 24in Touchpad (198.12cm x 60.96cm) Recommended for lanes 84 to 96 inches wide			TP-78F	40 lbs (18.1 kg)
96in x 22in Touchpad (243.84cm x 55.88cm)	TP-96	45 lbs (20.4kg)		

All touchpads have a thickness of .3in (.76cm)

*Flatwall touchpads are 3in (7.6cm) wider than gutterhung touchpads

Revised 04/10

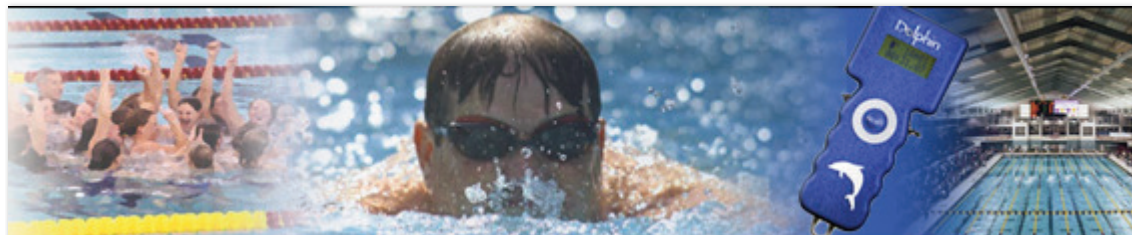

Profile Gutter Diagram

When ordering touchpads, select the diagram that best depicts your pool gutter.
Enter all requested dimensions and note water level. Please return by mail or fax to:
Colorado Time Systems - Sales Department, 1551 E. 11th Street, Loveland, CO 80537
Phone: 970-667-1000 • Fax: 970-667-5876

School/Organization

Name _____

Phone _____

Fax _____

Email _____

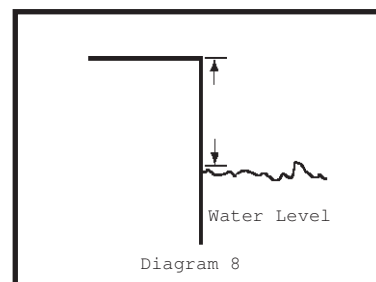
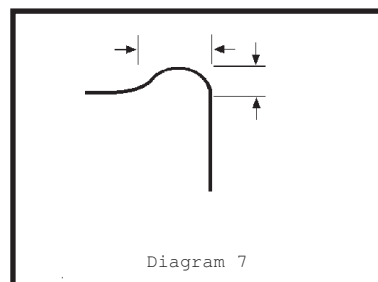
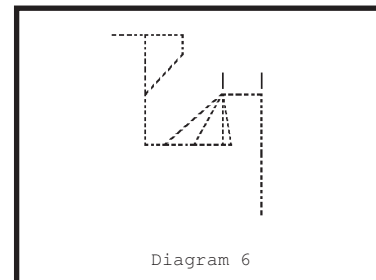
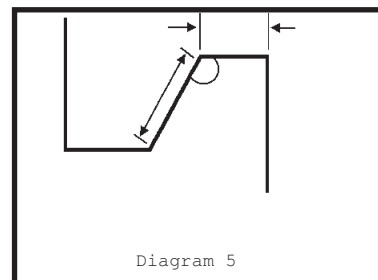
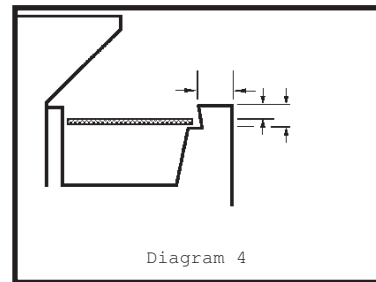
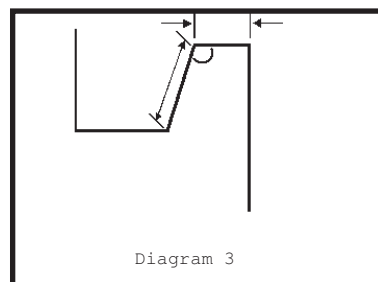
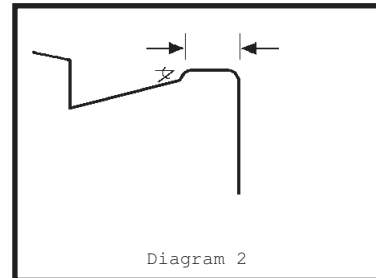
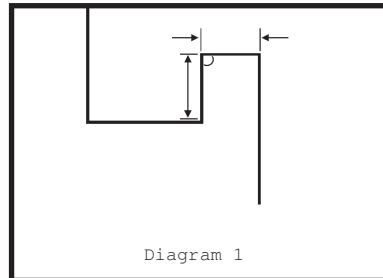

Revised 04/10

